

MARK II Di866 PROFESSIONAL

DIGITAL TTL POWER ZOOM FLASH



INSTRUCTION MANUAL

Type N

NISSIN.JAPAN

Nissin

Nissin Japan Ltd., Tokyo
<http://www.nissin-japan.com>

Nissin Marketing Ltd., Hong Kong
<http://www.nissindigital.com>

N1110 REV. 1.5

Thank you for purchasing a Nissin product

Before using this flash unit, please read this instruction manual and refer your camera owner's manual carefully to get a better understanding of proper operation to enjoy flash photography.

Nissin Di866 Mark II type Nikon is designed for Nikon digital SLR and hotshoe type cameras, listed below, with the latest TTL flash control system, and features Nissin's original rotating color display easily guiding its operations.

It works automatically with Nikon's i-TTL auto-flash system.

Please note that Di866 Mark II type N is not usable with other branded cameras for TTL operation.

UNIQUE FUNCTION



The color display automatically rotates to allow for easy operation in both the horizontal and vertical positions.

SIMPLE OPERATION

When attaching Di866 Mark II on the camera, the basic flash exposure operation is fully controlled by the camera. It is the same idea as when you use the built-in camera flash, but it's placed on the hotshoe of the camera, instead of using the built-in flash.

ADVANCED FUNCTIONS

Di866 Mark II provides many advanced flash functions, too. Wireless TTL off camera flash technology, high speed shutter synchronization, frequent repeat-flash system, External Av priority setting, etc. are supported.

Compatible cameras

Please refer Nissin's compatibility chart shown in its home page for details.
<http://www.nissin-japan.com> or <http://www.nissindigital.com>

SAFETY INSTRUCTIONS

These safety instructions refer to important information on how to use this product safely and properly. Please read the following instructions before using the product.

WARNING

This sign refers the danger or serious damage.

- The flash unit contains high voltage electric parts. Do not try to open or repair the flash unit. Return it back to the repair service station or the store you bought it from.
- Do not touch the inside parts from the opening when the unit was dropped or broken.
- Do not shoot the flash directly to the eye at short distance. It may damage the eye.
- When taking flash picture, especially toward a baby, it is recommended to keep the flash unit at least 1 meter (3.3 feet) away from the subject. Or use diffuser or bounce the light to the ceiling or to the wall to soften its intensity.
- Do not place the flash unit near any flammable gas, chemical or such liquids. It may cause fire or electric shock.
- Do not touch the flash unit with wet hands or use in the water. The flash unit carries high voltage inside and it may cause an electric shock.
- Do not shoot the flash unit directly to the driver of automobiles or such vehicles.
- Do not set the flash window close to the human body and shoot, which may get burned.
- Place the batteries correctly in position. Placing the batteries in wrong polarity may cause leakage, exothermic heat or explosion.

CAUTIONS

This sign refers the damage or defect.

- Do not leave or store the flash unit in the temperature over 40°C, such as in the automobile.
- The flash unit is not water resistance. Keep the unit away from rain, snow and humidity.
- Do not use benzene, thinner or other alcoholic agents to clean the unit.
- Do not use this flash unit with the cameras which are not recommended in compatibility list at official website, otherwise it may damage the camera's circuitry.
- Remove the batteries when not in use for a longer period of time.
- Do not have a heavy impact to the flash unit, nor throw it onto a hard surface floor.
- When using the external power pack, read the safety instructions carefully and follow the operation manual.



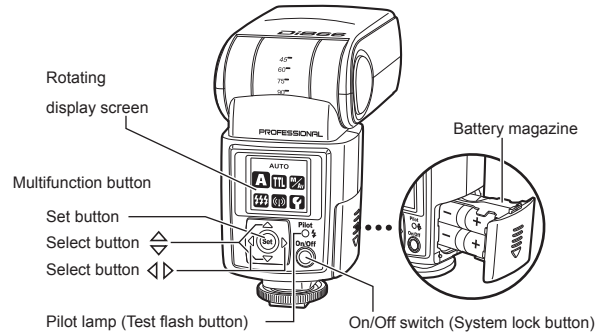
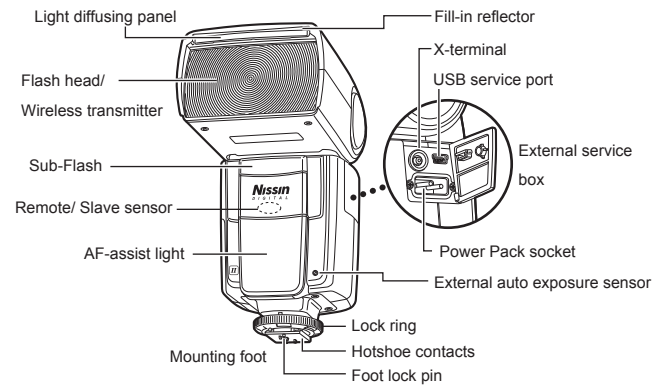



Nomenclature





MENU SCREEN FOR MAIN MODES

Di866 Mark II Flash Mode and Functions - to be set on the flash unit.





-  Full Automatic Mode
-  TTL Program Mode
-  Manual Setting Mode
-  Multi- flash Mode
-  Wireless Remote Flash Mode
-  Custom Setting Mode

 Full Automatic Mode _____ page 10
Flash light is fully controlled by the camera for the most proper exposure.

 TTL Program Mode _____ page 12
Flash light is automatically controlled by the camera but the flash exposure value can be compensated.

 Manual Setting Mode _____ page 16
Manual Mode - Selecting the desired manual power on the flash unit, Av priority Mode- Selecting the desired f-stop on the flash unit.

 Multi-flash Mode _____ page 22
Multiple lighting exposes the playback photos in one frame of picture.

 Wireless Remote Flash Mode _____ page 24
Placing multiple numbers of flashes (remote flash) off camera and controlling the creative TTL lighting.

 Custom Setting Mode _____ page 29
Variety of custom settings is available for own default value.

ADVANCED FUNCTIONS

Advanced functions are provided in some operation modes – to be set on the flash unit

Advanced Functions	Operation Modes	
	TTL Program Mode	Manual Setting Mode
Sub-Flash	TTL Program Mode	Manual Setting Mode
Manual Zoom	TTL Program Mode	Manual Setting Mode
Slave Mode	Manual Setting Mode	
F.Stop Setting	Manual Setting Mode*1	
ISO setting	Manual Setting Mode*2	

*1 Effective on at Universal Slave function in Manual Power operation and when using Di866 Mark II with film type camera or with non dedicated camera.

*2 Effective on Universal Slave function, and when using Di866 Mark II with film type camera or with non dedicated camera.

Functions by Camera setting – The flash is automatically controlled by the camera

 High speed shutter synchronization _____ page 31
Flash synchronizes to the faster shutter speed than regular synchronization speed.

 Rear curtain synchronization _____ page 31
The flash fires just before the rear curtain closes. A moving subject will appear such moving marks behind.

 Auto Flash Bracketing _____ page 31
Flash exposure level is automatically compensated on the sequence of frames pre-set in the camera.

 Red-eye reduction _____ page 32
Blinks of flash released before actual effective flash eliminate the red eye problem.

 Fv. Lock _____ page 32
Flash exposure can be locked at the main subject while moving the framing.

 Slow Shutter Synchronization _____ page 32
The flash is controlled at slow shutter speeds considering the dim condition of the background.

BASIC OPERATION

Inserting batteries

Usable batteries - Alkaline batteries, Lithium batteries, NiMH batteries.

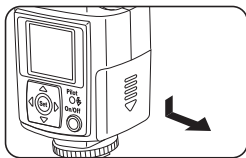

1. Remove the battery magazine and insert 4 x size AA batteries as shown in the picture.

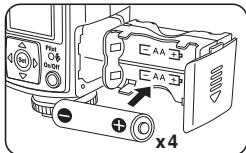

2. The battery compartment is specially designed so that every cell is placed in the same direction to avoid the confusion in poor light condition.

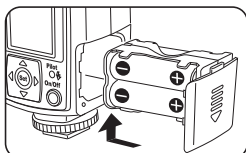

3. +/- symbol is clearly marked at the battery compartment.

4. Place the battery magazine back into the body.

When the recycle time becomes longer than 20 seconds, replace the batteries with the fresh ones or recharge the batteries (rechargeable batteries).

NOTE

It is recommended to use all 4 batteries in same brand and type, and replace them all at the same time.

Wrong insertion of each cell would not make electric contact.

Di866 Mark II has energy saving double power off function.

1. The power is automatically turned off (to stand-by mode), in about 30 seconds of idle use on the camera or after the last setting is made. To save the battery energy, you can select the display-off setting from the custom setting. In this case, the display screen turns off in about 8 seconds of idle use.
While Di866 Mark II is in the stand-by mode, the display screen turns off and the pilot lamp blinks every 2 seconds showing the flash unit is in stand-by mode.
To turn on Di866 Mark II again, press the camera's shutter button halfway or press any button of the flash unit.
2. In case Di866 Mark II is not in use for over 30 minutes, the unit is completely turned off. To turn on Di866 Mark II again, take the first step of turning the flash unit on.
In case of using the Di866 Mark II in off-camera-use mode (Wireless TTL flash-slave, Universal Slave function), it is recommended to change the turn off timer at the Custom setting...ref. page 29 .
The mode and the value set on the flash unit before turning off is memorized and returns in the same condition when switch it on again.

Mounting Di866 Mark II on the Camera

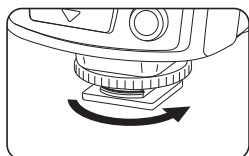

1. Turn off the power switch of both Di866 Mark II and the camera

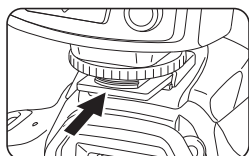

2. Turn the lock ring of Di866 Mark II to loosen it all the way as shown in the picture.

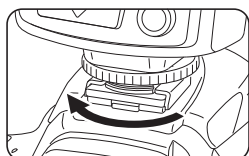

3. Slide the mounting foot of Di866 Mark II into the hotshoe of the camera.

4. Turn the lock ring to opposite direction and tighten it.

5. Lock pin comes out to hook the foot at the hotshoe for sure contact.

Removing Di866 Mark II from the Camera

- Loosen the lock ring and slide the mounting foot of Di866 Mark II off the hotshoe of the camera. Make sure to turn the lock ring all the way to completely clear the lock pin off the hooking slot on the hotshoe.

Turn on the flash unit

- Press the on / off switch. Screen A appears, and the mode A is set.
- The pilot lamp blinks red showing the unit is charging.
- In a few seconds, the pilot lamp turns green.
- The display screen automatically turns off in about 30 seconds after the setting job is terminated.
- For a test-flash, press the pilot lamp.
- To turn off the flash unit manually, press the on / off switch and hold it for 2 seconds.

SETTING THE MODE AND THE FUNCTION

A Full Automatic Flash Control

The modes to be set on the camera:

- [] (Full Auto), [**P**] (Program), [**S**] (Shutter priority),
[**A**] (Aperture priority), [**M**] (Manual),
 Night, Macro, Sport, Kids,
 Scene, Portrait, depending on the camera model.

In all those camera's modes listed above, Di866 Mark II will automatically and fully work in iTTL automatic flash control system.

- Set Di866 Mark II to the camera's hotshoe and press the on / off switch to power on.
- Display screen automatically shows **A**, the Full Automatic Mode.
- Di866 Mark II is now set for the camera's automatic flash control system.
- Press the on/off switch once again to lock this condition on your flash. (Press it again to release the lock)
- All the jobs required for this mode are completed.
- When the pilot lamp turns green, press the shutter button of your camera halfway to focus the subject.
- Shutter speed, aperture and flash mark () are shown in camera's view finder and the display panel of the camera.
- Press the shutter, and Di866 Mark II is fired. The result is immediately shown on the camera's LCD monitor.
- Flash power is automatically controlled by the camera and the most proper exposure is obtained on your picture.
- When you change the focal length of your camera lens, Di866 Mark II responds without delay and sets its light source for the proper illumination angle.



- The lens focal length you set is shown in the display screen of the flash unit.

The flash illumination coverage of Di866 Mark II responds to the lens focal length of 24mm to 105mm (full size format / film camera standard).

Set the camera's mode, select the focal length and take pictures with Di866 Mark II on your camera.
Di866 Mark II is a supplement to help you in taking creative and live picture. While you are taking pictures in Full Automatic mode, almost all jobs are automatically done by the camera and you just control the camera only.

Mode	Shutter Speed	Aperture Setting	Control on the camera
[]	Automatic	Automatic	Automatic
[P]	Automatic	Automatic	Automatic
[S]	Manual	Automatic	Any available shutter speed can be set.
[A]	Automatic	Manual	Any available f-stop can be set.
[M]	Manual	Manual	Any shutter speed / f-stop combination can be set.





With the latest TTL flash control system, the flash power level is always automatically controlled by the camera for the most appropriate exposure. You can soften or weaken the flash light, or give more light to the subject without changing the environmental or background exposure effect. Di866 Mark II can make it possibly quicker for each shot at respective occasion of flash picture.

The modes to be set on camera:



[] (Full Auto), [P] (Program), [S] (Shutter priority),

[A] (Aperture priority), [M] (Manual),



 Night,  Macro,  Sport,  Kids,

 Scene,  Portrait, depending on the camera model.

In all those camera's modes listed above, Di866 Mark II will automatically and fully work in iTTL automatic flash control system.

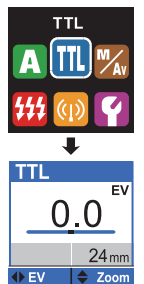
- Set Di866 Mark II to the camera's hotshoe and press the on / off switch to power on.
- Display screen shows A. Press set  and the display turns to the screen of 6 icons.
- Select TTL by select button  and set . Or the display returns back to the A mode screen in about 8 seconds.
- The TTL flash exposure compensation value 0.0Ev is shown as a default setting.
- TTL flash exposure compensation is provided in 19 steps by 0.3 Ev increment from -3.0 . . . 0 . . . to +3.0 Ev.



- Select   the compensation value you desire and set .
- To keep this value on your flash, press on / off switch to lock. (Press it again to release the lock)
- Take a picture and the aimed subject is shown with required lighting effect by keeping the exposure level of background as originally expected.
- On some cameras, the TTL flash exposure compensation can be set on the camera.
- When the flash exposure compensation is set on the flash unit, this value is to be counted in addition to the compensation value you set on the camera.
- The display screen of the flash unit however shows the exposure compensation value set on the flash unit only.

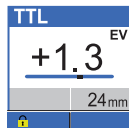

Set the camera's mode, select the flash exposure compensation value and take pictures.
Almost all jobs are automatically done by the camera with such compensation of the flash exposure value and you just manually control the camera only.





ADVANCED CUSTOM SETTING

An ADVANCED CUSTOM SETTING enables you to enjoy creative flash photography.

For advanced flash photography, the following two functions can be set on your flash.

Sub Flash Function

Di866 Mark II provides an extra small flash below the main flash. This small flash gives a fill-in light while bouncing the main flash. Bouncing the light may shadow the underside of face, and this fill-in flash brightens up the shadow.

- On the TTL function screen, press the set button  for 2 seconds.
- TTL Advance page appears.
- Select  Subflash and continuously select   the power and set  or wait for 8 seconds to returns to the TTL function screen.
- The following 8 powers are prepared in accordance with the photographic situation.

Subflash power	Guide No. at ISO100
1/1 (Full power)	12
1/2	8.5
1/4	6
1/8	4
1/16	3
1/32	2
1/64	1.5
1/128	1

- This subflash function is available only at bounce photography, and the mark SUB appears when tilting the flash head. When the flash head is set at the normal position, this mark disappears.

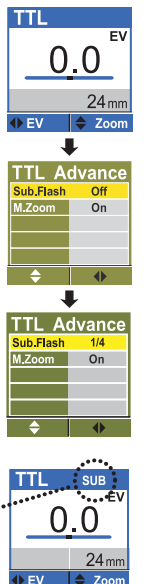

The reflector position of Di866 Mark II can be set manually. To get an illumination area different from the picture frame either wider or narrower field, manual zoom setting makes sense. When using Di866 Mark II with non-dedicated camera or traditional film type camera, the reflector position of Di866 Mark II does not respond to the camera lens movement. In this case, use this Manual Zoom Setting.

- On the TTL function screen, press the set button **Set** for 2 seconds.
- TTL Advance page appears.
- Select \diamond M.Zoom and continuously select $\blacktriangleleft \blacktriangleright$ on and set **Set** or wait for 8 seconds to returns to the TTL function screen and select \blacktriangleup the desired zoom setting from 24mm to 105mm and set **Set**.
- Be aware that now your Di866 Mark II will not adjust the zoom setting automatically when you change the focal length of your lens until you will have returned to "M.Zoom Off" on the TTL Advanced page.

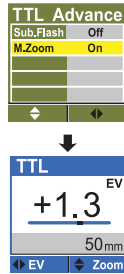

The mode to be set on the camera: [M] or [A]

Flash Power can be adjusted manually. The photographer can set the desired exposure manually by the most appropriate power settings are available, the aperture value set on the camera. 22 different power, from full power to 1/128 power, by every 1/3 stops are available.

- Set the camera mode, to [M] or [A] on your camera.
- Set the mode of Di866 Mark II. From the 6 icons screen, select $\blacktriangleleft \blacktriangleright \diamond$ M/Av and set **Set**.
- Select $\blacktriangleleft \blacktriangleright$ M and set **Set**.
- Select $\blacktriangleleft \blacktriangleright$ your desired power and set **Set**.
- The camera-subject distance for the most proper exposure is determined by the film speed (ISO) and the F stop set on the camera.
- This distance is shown in the Manual function screen.
- The film speed information (ISO) is automatically transferred from the camera.
- The F. stop you set on the camera is to be set manually on the flash unit, too.
- To get the camera-subject distance on the display screen, F. Stop setting is required.
- Press set **Set** for 2 seconds, the screen goes to the Advanced Function page for M mode.
- Move cursor \diamond to F.Stop line and continuously select $\blacktriangleleft \blacktriangleright$ the same F.Stop number you set on your camera.
- Press on / off switch to lock the value. (Press it again to release the lock)
- The distance is automatically followed by changing the focal length and ISO sensitivity level on the camera, or selecting the other power level.

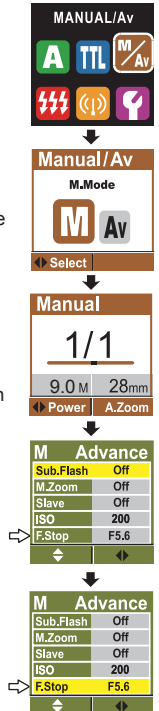

- As for the non-dedicated or traditional type film cameras, the film speed (ISO) information is not transferred from the camera.
- In this case, the film speed (ISO) is to be set on the flash unit to indicate the camera-subject distance.
- Move cursor \diamond to ISO line at Advanced function page and continuously select $\blacktriangleleft \blacktriangleright$ the ISO value to which you set camera. Press the set **Set** button or wait for 8sec. to return to M function screen.

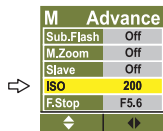

ADVANCED CUSTOM SETTING

Advanced custom setting is prepared in this mode

- Sub Flash Function _____ page 14
- Manual Zoom Setting _____ page 15
- Universal Slave Function _____ page 18

Di866 Mark II has a universal wireless remote flash system as a slave unit. You can enjoy creative flash photography with multiple lightings from the various directions. 2 slave modes are provided in accordance with the flash system of the master flash. Slave Digital (SD) for digital pre-flash system and Slave Film (SF) for an analogue flash system are available.

SD: In this mode Di866 Mark II synchronizes to pre-flash system. The master flash is to be set at iTTL mode.
SF: In this mode Di866 Mark II synchronizes to the traditional single flash system. The master flash is to be set at manual mode. Studio strobe lighting system synchronizes to this mode. This mode also responds to open flash and to traditional type flash unit in the market.

How to find SD or SF?

Select SD on your slave flash and release your camera's shutter to flash your master flash. The slave flash flashes if the Master flash is SD, and does not flash if the Master flash is SF. If your slave flash is set at SF, it flashes against both of SF and SD flash system.

- To set Di866 Mark II to the slave function mode, move cursor \diamond to Slave line at Advanced function page and continuously select $\blacktriangleleft \blacktriangleright$ SD or SF in accordance with the system of the master flash you set.
- Press the set **Set** button or wait for 8 seconds to return to M function screen.

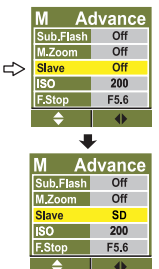

● Setting of Master and Slave flash:

Setting Master flash:

The master flash to be set is one unit only.

Place the master flash on the camera and switch it on, and set to Manual function mode or set the camera's built-in flash on. Make sure which mode you chose, digital pre-flash flash system or analogue flash system.

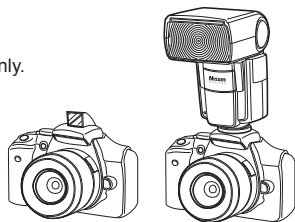

● Setting Slave flash Di866 Mark II:

Multiple numbers of flashes can be set. Switch Di866 Mark II on and select the appropriate slave system, either SD or SF.

When flash is set to the slave function, the red LED starts blinking every 2 seconds showing the slave function is in order. Make sure the mode you set, SD or SF which should couple with the master flash system.

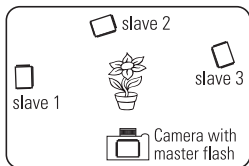

● Set slave flash at any place and direct the flash head as you desire. Slave sensor in the slave flash is facing to the camera or to the master flash.

● Use the included flash stand. Place Di866 Mark II on to the flash stand which can be placed either on a flat place or on the tripod by the screw.

NOTE

Metal type accessory shoe is not recommended since it may give electric damage on the electrical contact of the flash hotshoe.

When setting Di866 Mark II to the slave function, the zoom setting system is automatically set for the Manual Zoom at 24mm position. The zooming position can be selected manually to any other position available. In this mode, the auto-off timer is recommended to set at 60min. or be cancelled (off). The sensing angle of the slave sensor is 100° approx.



Av. Mode Operation

The mode to be set on the camera: [M] or [A]

The flash light is automatically controlled by the photo sensor built-in the flash unit instead of TTL metering. Select your desired F. Stop on Di866 Mark II and set this F. Stop on your camera. The intensity of flash light is automatically controlled for the most proper exposure within the certain area of distance.

- Set the camera mode, to [M] or [A] on your camera.
- Set the mode on Di866 Mark II. From the 6 icons screen, select ◀▶ M / Av and set **Set**.
- Select ◀▶ Av and set **Set**.
- F. Stop is displayed in the screen in accordance with the ISO setting on the camera.
- Select ◀▶ your desired F. Stop and set **Set** on the flash unit.
- Press on/off switch to lock the value. (Press it again to release the lock)
- Set the same F. Stop on your camera.
- The display screen shows the F. Stop selected, the camera-subject maximum distance for the proper exposure and the focal length set on the camera.
- The flash light is automatically controlled within the distance area. The shortest distance for the proper exposure is approximately 1.0m (3ft.) from the camera to the subject.
- The exposure varies by changing the focal length and F. Stop set on Di866 Mark II. This Av. mode of Di866 Mark II is not coupled with camera's aperture setting. The aperture setting on the flash unit is not controlled by the camera.
- When changing the ISO setting on the camera, the F. Stop of the flash unit is automatically reset for such corresponding ISO value.

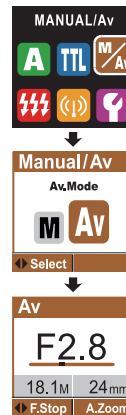

- In this case, reset this F. Stop on you camera.
- As for the traditional type film cameras, no ISO information or F. Stop information is transferred by the camera. In this case, set ISO value at the Advanced function page of Di866 Mark II.
- Press set **Set** for 2 seconds, the screen goes to the Advanced Function page for Av mode.

ADVANCED CUSTOM SETTING

Advanced custom setting is prepared in this mode.

- Sub Flash Function _____ page 14
- Manual Zoom Setting _____ page 15
- Universal Slave Function _____ page 18

In addition to the Manual power mode, the universal slave function supports Av operation mode.

Setting Slave flash: Select the slave mode SD or SF and set the desired F.stop and ISO speed on the Slave flash. As for setting Master flash, follow to the instruction manual in the Universal slave page at Manual power operation --- Page 16.



Multiple Flash Mode (Repeat flash/Stroboscopic flash)

The mode to be set on the camera: [M]

Repeating the flash illumination on the subject freezes the sequence of motion in one frame of picture.

In this mode, the power level, frequency and the number of flashes are to be set on the flash unit in advance.

Power Ratio:

Uncontrolled manual power is provided in 5 steps, from 1/8 to 1/128 power.

Frequency :

1 Hz to 90 Hz frequency can be set.

Flash Times :

1 time to 90 times can be set.

- Set the camera mode to M on your camera.
- Set the shutter speed on your camera in accordance with the guide table in the next page.
- Set the mode on Di866 Mark II. From the 6 icons screen, select ◀▶ and set **Set**.
- Value setting screen appears with the default values preset as shown.
- In this mode, the reflector zooming function is automatically set for option. Either Auto zoom or Manual zoom setting is selectable.
- Select the function and choose ◀▶ the desired value one by one.
- Press on/off switch to lock this condition.
- Or press set **Set** or wait for 8 seconds to return the multi flash function screen.
- The use of tripod is recommended for this flash mode.

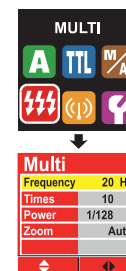

NOTE

The shutter speed to be set on the camera is calculated in the following formula.

$$\text{Number of flashes} \div \text{Frequency} = \text{Shutter Speed}$$

Example : To get 20 flashes at 10Hz → 20÷10=2

The shutter speed to be set on the camera is 2 seconds or longer.
Shutter for bulb setting is also available.

Guide Table for the number of flashes

Power	1	2	3	4	5	6-7	8-9	10	11	12-14	15-19	20-50	51-90
1/8	14	14	12	10	8	6	5	4	4	4	4	4	4
1/16	30	30	30	20	20	20	10	8	8	8	8	8	8
1/32	60	60	50	40	30	25	20	12	12	12	12	12	12
1/64	90	90	80	70	50	35	25	20	20	20	20	20	20
1/128	90	90	80	70	50	35	25	20	20	20	20	20	20

Caution

When using an external power pack, you may take continuous frames of multi-exposure pictures. Do not repeat multiple flash more than 10 continuous frames.

Take an interval of 10 to 15 minutes between shots. Flash source may be heated up and may cause serious damage to the flash unit.

Please note that the basic operation is however controlled by the main batteries(battery magazine) in the flash unit and when the main batteries are exhausted, flash control system does not work. Replace the batteries when recycle time becomes longer than 20 seconds by main batteries only. - ref. External Power Pack (page 34)



Wireless Remote Flash Mode

The mode to be set on the camera:

[] (Full Auto), [**P**] (Program), [**S**] (Shutter priority),

[**A**] (Aperture priority), [**M**] (Manual),

Di866 Mark II provides two possibilities of off camera wireless remote flash system.

This page explains Wireless Remote flash system. (The other system, universal slave flash system, is prepared at M and Av. mode - Ref. page 16 / 20)

The flash unit placed on the camera, connected by TTL off-camera flash cord is called "Master flash". The master flash to be set is one unit only.

The flash unit placed off the camera is called "Remote Flash". Multiple number of flashes can be set and controlled in 3 different groups (A, B and C group). 4 channels are prepared for signal transmission between the Master flash and the Remote flash.

Available combination of flash models and cameras

Wireless TTL Flash Pairing Chart

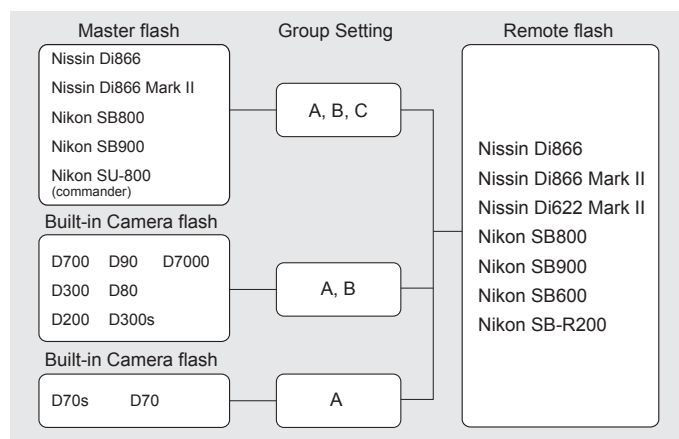

Remote flash

There is no limit of the number of remote flashes to be set at one time. It is however, recommended to set a maximum of 3 pcs in one group, as it may cause interference between flashes depending on the photographic conditions.

Use a flash stand to set the Remote flash. The stand provides the flash shoe and can stay either on the flat surface, or be placed on the tripod or light stand by the screw provided at the bottom.

When setting Di866 Mark II to Remote flash, it is recommended to cancel the auto-off setting or set it to 60 minutes at the Custom Settings - Ref. page 30. Refer your flash instruction manual for this function, which may differ according to the flash model.

At Remote flash mode, Di866 Mark II is set automatically for manual zoom setting and its reflector position is set for 24mm to cover the wider range of illumination. It is possible to set the desired flash coverage angle manually by select button .

Place the Remote flash in consideration to;

- 1.The remote flash does not shoot its light directly into the camera lens.
- 2.The wireless flash sensor of the Remote flash is not blocked.
- 3.The remote flash is usually not placed behind the master flash.
- 4.In the daylight synchronization, the sensor of remote flash could be saturated by sunlight and its response will be extremely reduced. In this case, the wireless TTL function may not result in success. Making a shade to cover the sensor of the remote flash is one of the ideas to help the situation.

Where is the Remote flash sensor?

Remote flash sensor is provided behind the front panel of Di866 Mark II at the name of Nissin DIGITAL. The sensor's sensing angle to respond to the incoming light is about 100°.

Setting the Master flash

The modes available on the Master flash are TTL and M mode. The master flash sets the signal transmission channel, flash reflector zooming position, flash mode of the master flash itself and flash mode and value adjustment of the Remote flash at A, B and C respectively.

- **In the main page**
Select Wireless mode.
- **In the Wireless page**
Select Master mode.
- **In the Master page**
Navigate the cursor and adjust the value according to the instruction at the bottom bar.
 - ▶▶ **Cursor Navigation**
 - ◀◀ **Value Adjust**
- **Channel Select**
Select Channel: Ch1, Ch2, Ch3 & Ch4
- **Zoom Select**
Select Zoom Mode: Auto, 24mm, 28mm, 35mm, 50mm, 70mm, 85mm, 105mm

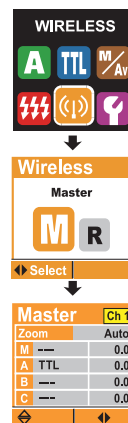

● **Group Setting**

- Group**
M = Master Flash
A = Group A
B = Group B
C = Group C

M	---	0.0
A	TTL	+3.0
B	---	0.0
C	M	1/84

Flash Mode

- TTL = TTL Mode
- M = Manual Mode
- = Flash off

Value Adjustment

Ev compensation at TTL mode (-3.0Ev to +3.0Ev)
Power Ratio at M mode (1/1, 1/2, 1/4, 1/8, 1/16, 1/32, 1/64, 1/128)

Setting the Remote flash

Channel, Group and the flash reflector zooming position are to be set on the Remote flash.

TTL and Manual mode is available on Remote Flash, which can however only be set by the Master flash.

- From the 6 icons screen, select and set **Set**. Select and set **Set**. AF assist light starts blinking every 2 seconds showing Di866 Mark II stands by in Remote Flash mode.
- Select the line channel and set the channel. 4 channels are available from 1 to 4.
- Select the line Group and set the group. 3 groups are available from A to C.
- Select the line Zoom and set zooming position.
- When setting Di866 Mark II to the Remote mode, the zoom setting system is automatically set at 24mm position. The zooming position can be selected manually to any other available position.
- Press on/off switch to lock this condition. (Press it again to release the lock).
- Or press set **Set**, or wait about 8 seconds. The screen shows the 6 icons screen and returns back to Remote setting page. The function and the value remain recorded as set.
- When placing more flashes, repeat the same operation procedures instructed above.
- The group can be chosen freely from A, B or C, but the channel of this bundle of wireless flash system is to be set in one common channel. The flash mode and the value can not be set on the Remote flash, but they are set by the Master flash only.



SETTING THE REMOTE FLASH

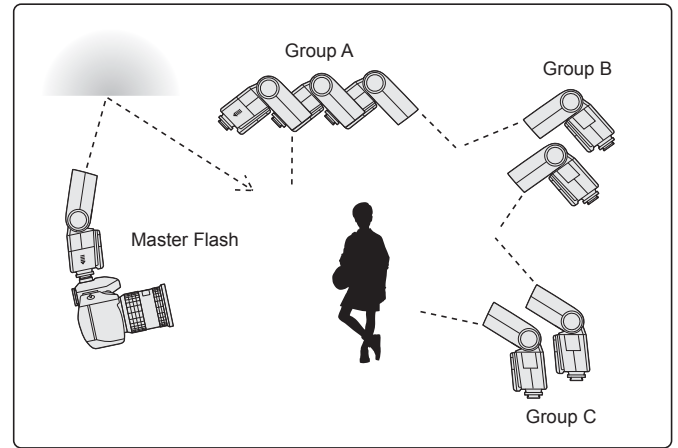

CREATIVE FLASH LIGHTING:

Set Master flash.

Set Remote flash/ flashes.

Make sure the channel and its group setting are correct.

Attach the Master flash to the camera and place the Remote flash/ flashes at any desirable place within the system operation area, which is approximately 7 to 10 meters between the Master and Remote flash/ flashes depending on the setting condition.



Custom settings

A variety of custom settings enable you to customize your Di866 Mark II.

- From 6 icons, select Custom setting mode and set **Set**.
- Select the item to be customized and set the value to customize.
- 7 custom settings are prepared.

My TTL TTL Exposure level custom setting

TTL exposure level is accurately calibrated for standard balance in accordance with Nissin's standard. If any adjustment is however required, or if you like to set your own preferable level, it can be adjusted for about ± 3 Ev. by every 1/3 steps.

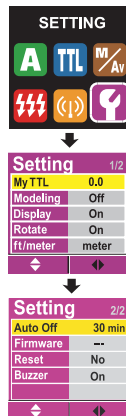

Modeling Illuminating the subject to find its lighting efficiency.

A short pulse of flash light released by the test button illuminates the subjects and monitors the lighting efficiency on the subject.

Display Display can be set off if it's not necessary.

To save battery energy, or simply to avoid the display illumination, the display screen can be switched off when not in operation. Set it off, and the display goes off in 8 seconds after the last operation. The display will not be woken up by the camera's shutter release. The display can only be woken up by any operation button of Di866 Mark II.

Rotate Cancel the rotating action and keep the image fixed. The screen won't rotate.

ft/meter For the user who prefers distance indication by feet. Select feet instead of meter.

Auto Off Auto off timing can be selected from 10min. 15min, 30min, 45min, 60min or off (cancel).

Firmware A firmware upgrade service is available for the Di866 Mark II, which provides a USB service terminal (By local service/ local dealer) to upload the latest software.

Reset All those customs setting is reset to the default value and conditions which are provided and set at the factory.

Buzzer This is available for Wireless Remote mode. When using Di866 Mark II as a slave remote flash, a "beep" sound indicates the master flash triggers successfully.

- Those customized values and conditions are effective on all modes and memorized even when the flash unit is switched off.
- To reset the customized value or conditions, select Reset, choose "Yes" and set **Set**. All the memorized data is cancelled and Di866 Mark II is reset to the default value and condition.

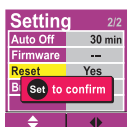

You do not need to set the flash unit for these functions.

HS High speed shutter synchronization

This function is available at A mode and TTL mode. Di866 Mark II produces FP flash beam and synchronizes to the highest shutter speed set on the camera. To capture subject with softening off the back ground in daylight synchronization photography, the shutter speed is to set at higher than the regular synchronization speed. When the camera shutter is set at the faster shutter speed, a mark FP is shown in the display screen on Di866 Mark II and the flash system is automatically set for FP flash beam.

↔ Rear curtain synchronization

All modes except Multiple flash mode are available for this sync. system. In rear-curtain sync., the flash fires just before the rear curtain closes. By using this function at slow shutter speeds, a moving subject will appear with moving marks behind. Refer to the operation manual of the camera for details.

0 + Auto Flash Bracketing

Di866 Mark II supports this function at A mode and TTL mode. By setting this function on the camera, you will get continuous flash pictures in the different exposure effect on each frame. Exposure compensation ratio, number of picture frame is to be set on the camera. Refer the operation manual of the camera for details.

⚡ Red-eye reduction

To prevent the subject's eyes from appearing red, Di866 Mark II fires three controlled flashes just before the picture is taken. Red-eye reduction can be combined with slow sync. Red-eye reduction flash is produced at all modes of Di866 Mark II. Refer the operation manual of the camera for details.

Fv. Lock Fv. Lock

Di866 Mark II offers this function at A and TTL mode. Focus the main subject and press <AE-L> button on the camera (or <AF-L > button on some camera Exposure value on the main subject is memorized in the flash. Aim the viewfinder center over the main subject and release the shutter.



SLOW Slow Shutter Synchronization

All modes in Di866 Mark II support the slow shutter synchronization. The flash is controlled at a slow shutter speed to trace the correct exposure on both the main subject and back ground in low light conditions or at night. The slow shutter speed produces a blurring effect of the subject and a sharp flash beam freezes the moment. A combination of slow shutter and flash light creates a motion image in the still picture.



OTHER FEATURES

AF assist light emitter

Under the low light condition or in a dark place, AF assist light will automatically emit the red colored beam and illuminate the subject so that the camera can easily focus the subject in darkness.

Fill-in reflector and Light diffusing panel built-in

For short distance or portrait flash photography, the light should not be too sharp or too strong on the subject. Use fill-in reflector flash or diffuse the light.

- If the subject is close (within 2 meters), turn the flash head 90° upward and pull out the fill-in reflector as shown in the picture.
- Take a picture as usual. A blink of fill-in flash freshens up the subject in natural image.
- This small blink of flash is also useful when taking a picture of baby without scaring him. Pull out the light diffusing panel and place it over the flash window as shown in the picture.
- The diffusing panel softens the flash light and creates a lively color effect upon the subject.
- Since the light diffusing panel expands the lighting area, it covers the range of 18mm of focal length lens.

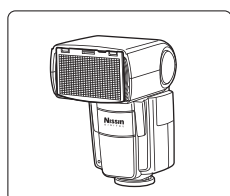
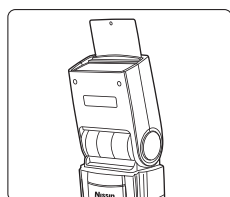
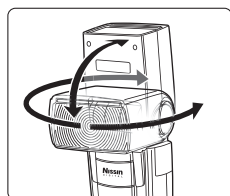

Bounce Lighting

When taking a picture of a baby or small children, do not shoot the flash straight onto them. Bounce the light off the ceiling or wall so that it won't scare them.

When pointing the flash to a subject in front of the wall, it creates an unexpected sharp shadow on the wall which results in poor picture quality. Bounce the light off the ceiling or wall to soften the light over the subject, and the shadow fades out.

Turn the flash head upwards or sideways. The wall or ceiling in this case should be flat surface and white color is preferable. Colored ceiling or wall may reflect its color on the subject.

External Power Pack Socket

When using an external power source, the number of flashes is increased and the recycling time is shortened. The following external power pack is available in option.



Di866 Mark II is automatically turned off when repeating flash continuously over

Battery = NiMH battery	Operation Modes	Recycle time
Nissin Power Pack PS 300	500 flashes	0.7 sec.
Nikon SD-8A / SD-9	200 flashes	1.5 sec.

20 to 30 times to protect the flash circuitry. It will be automatically reset after 15 minutes of inactivity.

Please note that the basic operation is controlled by the main batteries(battery magazine) in the flash unit and when the main batteries are exhausted, the flash control system does not work. Replace the batteries when recycle time becomes longer than 20 seconds by main batteries only.

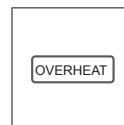

USB Service Port



Tired of your flash no longer working whenever a new camera comes onto the market? A firmware upgrade service is available for the Di866 Mark II, which provides a service terminal to upload the latest software. A service charge for the firmware upgrade will be applied, varying with different region. Please check at your local dealer for details about the update service.

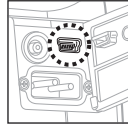

X terminal



Di866 Mark II can be used with non-hotshoe cameras. Some cameras provide a flash synchronization contact at x-terminal instead of hotshoe. For this type of cameras, Di866 Mark II has a x-terminal socket for flash synchronization. A standard sync-cable in the market is usable.

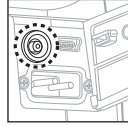

Off-camera shoe cord (Optional)

Di866 Mark II can be used together with Nissin SC-01 (Off Camera Shoe Cord). The cord provides a TTL hot shoe at the main body. It enables the attachment of two flash units at the same time. One on top of the camera and one off camera.

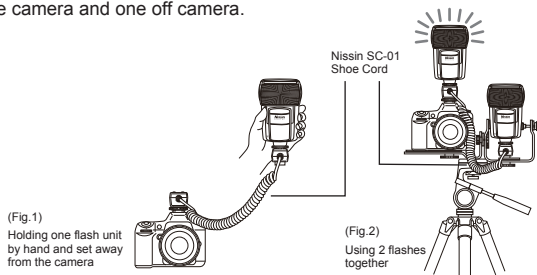

(Fig.1)
Holding one flash unit by hand and set away from the camera

(Fig.2)
Using 2 flashes together

* It is not possible to shoot two flashes at the same time.

SPECIFICATIONS

Usable cameras	Nikon iTTL flash system SLR and hotshoe type
Guide No.	Compact digital cameras-ref. Nissin official website for camera models. 60 / 198 at 105mm focal length (ISO 100 m/ft) 40 / 132 at 35mm focal length (ISO 100 m/ft)
Wattage	83 Ws. at full power
Illumination coverage	24-105mm (18mm with diffuser panel built-in)
Power source	4 x LR6 batteries (Size AA Ni-MH or lithium batteries usable)
Battery life	150-1500 flashes according to the mode (with alkaline batteries)
Energy Saving	Come to Stand-by mode in 30 seconds, and Power off timer can be set
Recycle timer	5.5 seconds with fresh alkaline batteries for full power
Flash Exposure	iTTL for Nikon digital SLR cameras Automatic exposure metering by external photo sensor Manual exposure (Power ratio available)-Ref G.No. table
AF assist light	Effective range of approx. 0.7 to 10 m / 2.3 to 33 ft.
Color Temperature	5600 K at full power flash
Flash Duration	1/300 seconds (full power flash) 1/300-1/30,000 seconds (controlled flash) FP flash for high speed synchronization
Wireless flash	Wireless TTL off camera flash system Wireless Master mode Wireless Remote mode Slave flash function at external auto-exposure Slave to digital pre-flash system Slave to traditional single flash system
External Power Pack	Service socket for the external power pack(optional accessory) Nissin Power Pack PS300 Nikon Power Assist Pack SD-8A and SD-9
USB service port	For firmware update service USB cord is not included
Sync. Contact	Camera's hot shoe-iTTL for Nikon system Traditional sync. System X-terminal socket
Dimensions	74 x 134 x 110mm (2.92 x 5.3 x 4.35 inch)
Weight	380g

Guide Number and Flash duration table

Guide No. at manual exposure mode (ISO 100 in meters)

Flash Power Level

Zoom position	Full	1/2	1/4	1/8	1/16	1/32	1/64	1/128
24mm	31	22	16	11	8	5.5	4	2.5
28mm	36	25	18	12.5	9	6.5	4.5	3
35mm	40	28	20	14	10	7	5	3.5
50mm	46	32	23	16	11.5	8	5.5	4
70mm	52	36	26	18	13	9	6.5	4.5
85mm	54	38	27	19	13.5	9.5	7	5
105mm	60	42	30	21	15	10.5	7.5	5.5
Flash Duration (second)	1/600	1/900	1/1500	1/3200	1/5000	1/9000	1/15000	1/22000

TROUBLE SHOOTING

The flash unit does not start charging.

- Batteries are not correctly installed
>>> Install batteries to correct problem.

- Batteries are exhausted
>>> Replace the batteries if the recycle time is beyond 20 seconds

The flash unit does not flash.

- The flash unit is not firmly clipped on the camera
>>> Mount the flash unit firmly on the camera's hot shoe.
- The flash unit is automatically powered off
>>> Turn on the switch again.

The flash picture is overexposed or underexposed.

- There is a reflective object or strong lighting near the subject.
>>> Use Fv lock.
- The unit is set for manual exposure mode at wrong distance
>>> Set to TTL mode or select other power level.

WARRANTY

In case of the following reasons of the defect, it may void the warrantee. Please refer to the respective warranty condition for details which varies from different countries.

1. The product is not used in accordance with the instruction of the owner's manual.
2. The product is repaired or modified by the one who is not an authorized repair service provider.
3. When the product is used with the inapplicable cameras, lens or adaptors or such accessories produced by the third party.
4. Fault or defect caused by fire, earthquake, flood, public pollution and such natural accidents.
5. in the case that the product is stored in dust, moisture, extremely high temperature or such poor conditions.
6. Scratch, blemish, crush or worn out by a violently use or treatment.
7. Guarantee card without the name of place purchased or the date of purchase stamped, or no guarantee card.

