

Di866 PROFESSIONAL

DIGITAL TTL POWER ZOOM FLASH



INSTRUCTION MANUAL

Nissin

Nissin Japan Ltd., Tokyo
<http://www.nissin-japan.com>

Nissin Marketing Ltd., Hong Kong
<http://www.nissindigital.com>

C0909 REV. 1.2

Thank you for purchasing a Nissin product

Before using this flash unit, please read this instruction manual and refer to your camera owner's manual carefully to get a better understanding of proper operation to enjoy flash photography.

Nissin Di866 type Canon is designed for Canon digital SLR, with the latest TTL flash control system, and features Nissin's original rotating color display easily guiding its operations.

It works automatically with Canon E-TTL/ E-TTL II auto-flash system. Please note that Di866 type C is not usable with other branded cameras for TTL operation.

UNIQUE FUNCTION

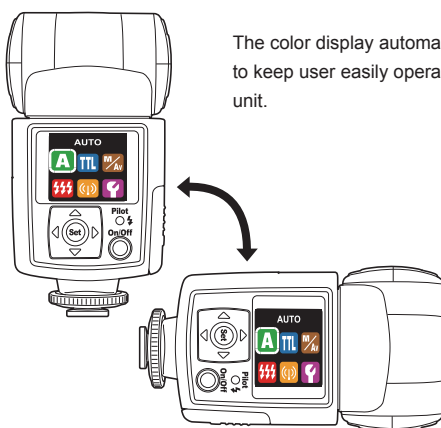

The color display automatically rotates to keep user easily operate the flash unit.

SIMPLE OPERATION

When attaching Di866 to the camera, the basic flash exposure operation is fully controlled by the camera. It is the same idea as you use the built-in camera flash, but it is placed on the hotshoe of the camera instead of built-in.

ADVANCED FUNCTIONS

Di866 provides many advanced flash functions. Wireless TTL off camera flash technology, high speed shutter synchronization, frequent repeat-flash system, External Av priority setting, etc. are supported.

Compatible cameras

Please refer Nissin's compatibility chart shown in its home page for details.
<http://www.nissin-japan.com> or <http://www.nissindigital.com>

SAFTY INSTRUCTIONS

This safety instructions refer important information to use the product safely and properly. Please read the following instructions before using the product.

⚠ WARNING

This sign refers the danger or serious damage.

- The flash unit contains high voltage electric parts. Do not try to open or repair the flash unit. Return it back to the repair service station or the store you bought it.
- Do not touch the inside parts from the opening when the unit was dropped or broken.
- Do not shoot the flash directly to the eye at short distance. It may damage the eye.
- When taking flash picture, especially toward a baby, it is recommended to keep the flash unit at least 1 meter (3.3feet) away from the subject.
Or use diffuser or bounce the light to the ceiling or to the wall to soften its intensity.
- Do not place the flash unit near any flammable gas, chemical or such liquids. It may cause fire or electric shock.
- Do not touch the flash unit with wet hands or use in the water. The flash unit carries high voltage inside and it may cause an electric shock.
- Do not shoot the flash unit directly to the driver of automobiles or such vehicles.
- Do not set the flash window close to the human body and shoot, which may get burned.
- Place the batteries correctly in position. Placing the batteries in wrong polarity may cause leakage, exothermic heat or explosion.

⚠ CAUTIONS

This sign refers the damage or defect.

- Do not leave or store the flash unit in the temperature over 40°C, such like in the automobile.
- The flash unit is not water resistance. Keep the unit away from rain, snow and humidity.
- Do not use benzene, thinner or other alcoholic agents to clean the unit.
- Do not use this flash unit with the cameras which is not recommended in this instruction manual, otherwise it may damage the camera's circuitry.
- Remove the batteries when not in use for a longer period of time.
- Do not have a heavy impact to the flash unit, nor throw it onto a hard surface floor.
- When using the external power pack, read the safety instruction carefully and follow the operation manual.

Nomenclature

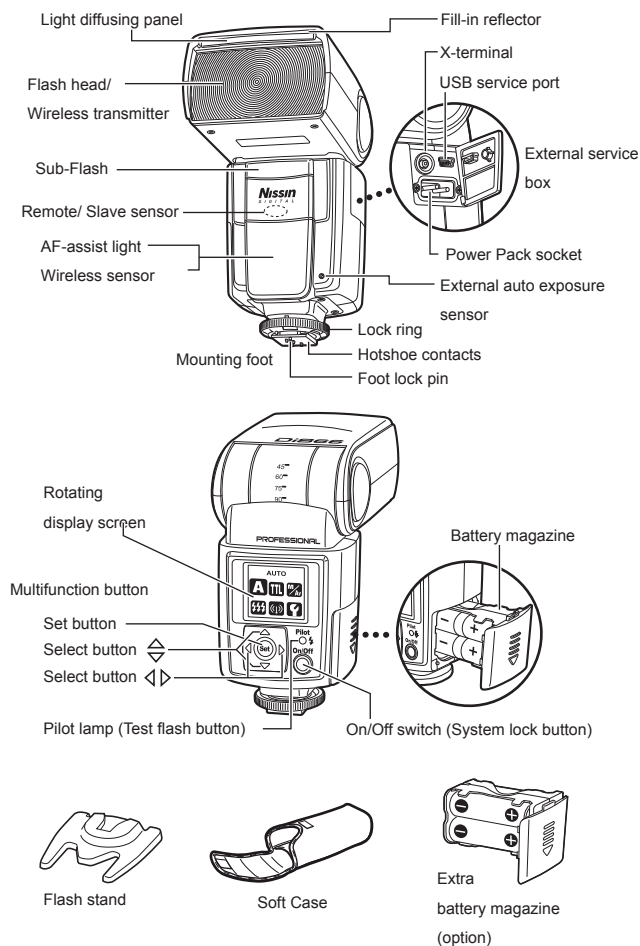

MENU SCREEN FOR MAIN MODES

Di866 Flash Mode and Functions - to be set on the flash unit.

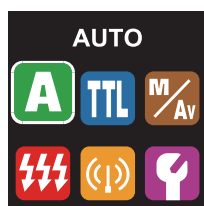

- A** ... Full Automatic Mode
- TTL** ... TTL Program Mode
- M/Av** ... Manual Setting Mode
- ⚡** ... Multi- flash Mode
- Ⓜ** ... Wireless TTL Flash Mode
- Ⓜ** ... Custom Setting Mode

A Full Automatic Mode _____ page 10
Flash light is fully controlled by the camera for the most proper exposure. exposure.

TTL TTL Program Mode _____ page 12
Flash light is automatically controlled by the camera but the flash exposure value can be exposure value can be compensated.

M/Av Manual Setting Mode _____ page 17
Manual Mode -Selecting the desired manual power on the flash unit,
Av priority Mode- Selecting the desired f-stop on the flash unit.

⚡ Multi-flash Mode _____ page 23
Multiple lighting exposes the playback photos in one frame of picture.

Ⓜ Wireless TTL Flash Mode _____ page 25
Placing multiple numbers of flashes (remote flash) off camera and controlling the creative controlling the creative TTL lighting.

Ⓜ Custom Setting Mode _____ page 32
Variety of custom settings is available for own default value.

ADVANCED FUNCTIONS

Advanced functions are provided in some operation modes – to be set on the flash unit

Advanced Functions	Operation Modes	
Sub-Flash	TTL Program Mode	Manual Setting Mode
Manual Zoom	TTL Program Mode	Manual Setting Mode
Slave Function	Manual Setting Mode	
F.Stop Setting*1	Manual Setting Mode	
ISO setting*2	Manual Setting Mode	

*1 Effective on at Universal Slave function in Manual Power operation and when using Di866 with film type camera or with non dedicated camera.

*2 Effective on Universal Slave function, and when using Di866 with film type camera or with non dedicated camera.

Functions by Camera setting – The flash is automatically controlled by the camera

FE. Lock FE. Lock _____ page 33
Flash exposure can be locked at the main subject while moving the framing.

BASIC OPERATION

Inserting batteries

Usable batteries - Alkaline batteries, Lithium batteries, NiMH batteries.

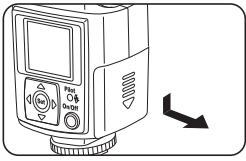

1. Remove the battery magazine and insert 4 x size AA batteries as shown in the picture.
2. The battery compartment is specially designed so that every cell is placed in the same direction to avoid the confusion in poor light condition.
3. +/- symbol is clearly marked at the battery compartment.
4. Place the battery magazine back into the body.

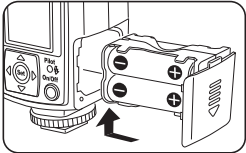
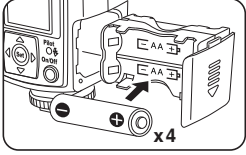

When the recycle time becomes longer than 20 sec., replace the batteries with the fresh ones or recharge the batteries (rechargeable batteries).

NOTE

It is recommended to use all 4 batteries in same brand and type, and replace them all at the same time.
Wrong insertion of each cell would not make electric contact.

7

Mounting Di866 on the Camera

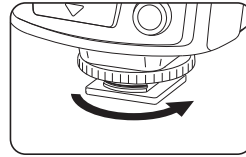

1. Turn off the power switch of both Di866 and the camera
2. Turn the lock ring of Di866 to loosen it all the way as shown in the picture.

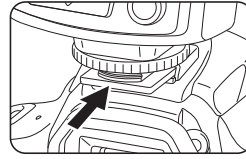

3. Slide the mounting foot of Di866 into the hotshoe of the camera.

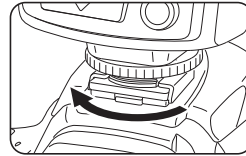

4. Turn the lock ring to opposite direction and tighten it.
5. Lock pin comes out to hook the foot at the hotshoe for sure contact.

Removing Di866 from the Camera

- Loosen the lock ring and slide the mounting foot of Di866 off the hotshoe of the camera. Make sure to turn the lock ring all the way to completely clear the lock pin off the hooking slot on the hotshoe.

Turn on the flash unit

- Press the on/off switch. Screen A appears, and the mode A is set.
- The pilot lamp blinks red showing the unit is charging.
- In a few seconds, the pilot lamp turns green.
- The display screen automatically turns off in about 30sec. after the setting job is terminated.
- For a test-flash, press the pilot lamp.
- To turn off the flash unit manually, press the on/off switch and hold it for 2 seconds.

8

Di866 has energy saving double power off function.

1. The power is automatically turned off (to stand-by mode), in about 30 sec. of idle use on the camera or after the last setting job. To save the battery energy, you can select the display-off setting from the custom setting. In this case, the display screen turns off in about 8 sec. of idle use. While Di866 is in the stand-by mode, display screen turns off and the pilot lamp blinks every 2 seconds showing the flash unit is in stand-by mode. To turn on Di866 again, press the camera's shutter button halfway or press any button of the flash unit.
2. In case Di866 is not in use over 30 minutes, the unit is completely turned off and shut out the current leakage from the batteries. To turn on Di866 again, take the first step of turning the flash unit on. In case of using Di866 in off-camera-use mode (Wireless TTL flash-slave, Universal Slave function), it is recommended to change the turn off timer at the Custom setting....ref. page 32 . The mode and the value set on the flash unit before turning off is memorized and returns in the same condition when switch it on again.

9

SETTING THE MODE AND THE FUNCTION

A Full Automatic Flash Control

The modes to be set on the camera:

[] (Full Auto), [P] (Program), [Tv] (Shutter priority),

[Av] (Aperture priority), [M] (Manual), [A-DEP] Automatic depth-of-field,

Portrait, Landscape, Close-up, Sports,

Night Portrait.

In all those camera's modes listed above, Di866 will automatically and fully work in E-TTL automatic flash control system.

- Set Di866 to the camera's hotshoe and press the on/off switch to power on.
- Display screen automatically shows A, the Full Automatic Mode.
- Di866 is now set for the camera's automatic flash control system.
- Press the on/off switch once again to lock this condition on your flash. (Press it again to release the lock)
- All the jobs required for this mode is completed.
- When the pilot lamp turns green, press the shutter button of your camera halfway to focus the subject.
- Shutter speed, aperture and flash mark () are shown in camera's view finder and the display panel of the camera.
- Press the shutter, and Di866 is fired. The result is immediately shown on the camera's LCD monitor.
- Flash power is automatically controlled by the camera and the most proper exposure is obtained on your picture.
- When you change the focal length of your camera lens, Di866 responds without delay and set its light source for the proper illumination angle.



10

- The lens focal length you set is shown in the display screen of the flash unit.

The flash illumination coverage of Di866 responds to the lens focal length of 24mm to 105mm (full size format/film camera standard).

Set the camera's mode, select the focal length and take pictures with Di866 on your camera.
Di866 is a supplement to help you taking a creative and live picture. While you are taking pictures in Full Automatic mode, almost all jobs are automatically done by the camera and you just manually control the camera only.

Mode	Shutter Speed	Aperture Setting	Control on the camera
[O]	Automatic	Automatic	Automatic
[P]	Automatic	Automatic	Automatic
[Tv]	Manual	Automatic	Any available shutter speed can be set.
[Av]	Automatic	Manual	Any available f-stop can be set.
[M]	Manual	Manual	Any shutter speed / f-stop combination can be set.



TTL Flash Exposure Value Compensation

With the latest TTL flash control system, the flash power level is always automatically controlled by the camera for the most appropriate exposure. You can soften or weaken the flash light, or give more light to the subject without changing the environmental or background exposure effect. Di866 can make it possibly quicker for each shot at respective occasion of flash picture.

The modes to be set on camera:

- [**O**] (Full Auto), [**P**] (Program), [**Tv**] (Shutter priority), [**Av**] (Aperture priority), [**M**] (Manual), [**A-DEP**] Automatic depth-of-field,
- Portrait, Landscape, Close-up, Sports,
- Night Portrait.

In all those camera's modes listed above, Di866 will automatically and fully work in ETTL automatic flash control system.

- Set Di866 to the camera's hotshoe and press the on/off switch to power on.
- Display screen shows A. Press set and the display turns to the screen of 6 icons.
- Select TTL by select button and set . Or the display returns back to the A mode screen in about 8 seconds.
- The TTL flash exposure compensation value 0.0Ev is shown as a default setting.
- TTL flash exposure compensation is provided in 19 steps by 0.3Ev increment from -3.0 . . . 0 . . . to +3.0Ev.

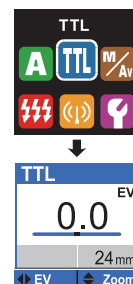

- Select the compensation value you desire and set .
- To keep this value on your flash, press on/off switch to lock. (Press it again to release the lock)
- Take a picture and the aimed subject is shown with required lighting effect by keeping the exposure level of background as originally expected.
- On some cameras, the TTL flash exposure compensation can be set on the camera.
- When the flash exposure compensation is set on the flash unit, this value is to be counted in addition to the compensation value you set on the camera.
- The display screen of the flash unit however shows the exposure compensation value set on the flash unit only.

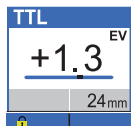

Set the camera's mode, select the flash exposure compensation value and take pictures.
Almost all jobs are automatically done by the camera with such compensation of the flash exposure value and you just manually control the camera only.

ADVANCED CUSTOM SETTING

An ADVANCED CUSTOM SETTING enables you to enjoy creative flash photography.

For advanced flash photography, the following two functions can be set on your flash.

Sub Flash Function

Di866 provides an extra small flash below the main flash. This small flash gives a fill-in light while bouncing the main flash. Bouncing the light may shadow the underside of face, and this fill-in flash brightens up the shadow.

- On the TTL function screen, press the set button for 2 sec.
- TTL Advance page appears.
- Select Subflash and continuously select the power and set or wait for 8 seconds to returns to the TTL function screen.
- The following 6 powers are prepared in accordance with the photographic situation.

Subflash power	Guide No. at ISO100
1/1 (Full power)	12
1/2	8.5
1/4	6
1/8	4
1/16	3
1/32	2

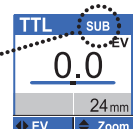
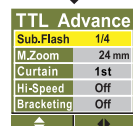
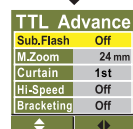
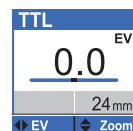

- This subflash function is available only at bounce photography, and the mark SUB appears when tilting the flash head. When the flash head is set at the normal position, this mark disappears.



Manual Zoom Setting

The reflector position of Di866 can be set manually.

To get an illumination area different from the picture frame either wider or narrower field, manual zoom setting makes a sense. When using Di866 with non-dedicated camera or traditional film type camera, the reflector position of Di866 does not respond to the camera lens movement. In this case, use this Manual Zoom Setting.

- On the TTL function screen, press the set button **Set** for 2 sec.
- TTL Advance page appears.
- Select **M.Zoom** and continuously select **◀▶** on and set **Set** or wait for 8 seconds to returns to the TTL function screen.

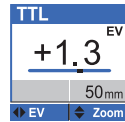
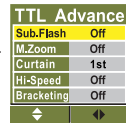

2nd (rear) curtain synchronization

Flash usually synchronizes to the camera shutter when it opens (1st curtain sync.). For the slow shutter photography, Di866 can be set the flash timing just before the shutter closes (2nd curtain sync.). By using this function, a moving subject is imaged with such moving marks behind. Refer the camera owner's manual for details.

- On the TTL function screen, press the **Set** button for 2 sec.
- TTL Advance page appears.
- Select 'Curtain' by **◀▶** button.
- Select **2nd** for 2nd Curtain Sync by **◀▶** button.
- Press the **Set** button or wait for 8 sec to return to the TTL function screen.
- A symbol '>>>' appears at the upper right hand corner for 2nd Curtain Sync, while no symbol appears for normal flash sync. (1st curtain)

15

Hi-Speed Sync

The flash of Di866 can be set for camera with higher shutter speeds up to 1/8000 second.

- On the TTL function screen, press the **Set** button for 2 sec.
- TTL Advance page appears.
- Select 'Hi-Speed' by **◀▶** button.
- Select 'On' for High-Speed Sync by **◀▶** button.
- Press the **Set** button or wait for 8 sec to return to the TTL function screen.
- A symbol **⚡** appears at the upper right hand corner for High-Speed Sync

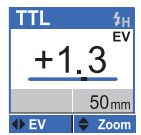

Flash Exposure Bracketing (FEB)

Di866 supports exposure bracketing function at every 0.3Ev increment within the range of ± 3 Ev. You will get 3 continuous flash pictures in different exposure effects on each frame. Set the camera shutter for drive mode and number of picture frame is to be set on the camera. Refer the camera owner's manual for details.

- On the TTL function screen, press the **Set** button for 2 sec.
- TTL Advance page appears.
- Select 'Bracketing' by **◀▶** button.
- Select 'On' for Bracketing by **◀▶** button.
- Select your favorite EV step from ± 0.3 to ± 3 for Bracketing by **Set** button.
- Press the **◀▶** button or wait for 8 sec to return to the TTL function screen.
- A 'BKT1' symbol appears at the upper right hand corner for Bracketing.

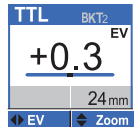

Remark:

IMAGE ZONE (Full Auto, Portrait, Landscape, Close-up, Sports, Night Portrait) When setting the camera mode to any of those image zone, Di866 is automatically set at TTL-AUTO function mode. In this mode, TTL exposure level compensation can not be adjusted. All other advance functions are available.

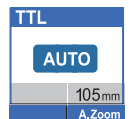

16

M/Av Manual Power Operation

The mode to be set on the camera: [M] or [Av]

Flash Power can be adjusted manually at option. The photographer can set his desired exposure manually by the most appropriate power in combination with the aperture value set on the camera. 22 different power, from full power to 1/128 power, by every 1/3 stops are available.

- Set the camera mode, to [M] or [Av] on your camera.
- Set the mode of Di866. From the 6 icons screen, select **M/Av** and set **Set**.
- Select **M** and set **Set**.
- Select your desired power and set **Set**.
- The camera-subject distance for the most proper exposure is determined by the film speed (ISO) and the F stop set on the camera.
- This distance is shown in the Manual function screen.
- The film speed information (ISO) is automatically transferred from the camera.
- The F. stop you set on the camera is to be set manually on the flash unit, too.
- To get the camera-subject distance on the display screen, F. Stop setting is required.
- Press set **Set** for 2 seconds, the screen goes to the Advanced Function page.
- Move cursor **◀▶** to F.Stop line and continuously select **◀▶** the same F.Stop number you set on your camera.
- Press on/off switch to lock the value. (Press it again to release the lock)

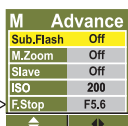

The distance is automatically followed by changing the focal length and ISO sensitivity level on the camera, or selecting the other power level.

17

- As for the non-dedicated or traditional type film cameras, the film speed (ISO) information is not transferred from the camera.
- In this case, the film speed (ISO) is to be set on the flash unit to indicate the camera-subject distance.
- Move cursor **◀▶** to ISO line at Advanced function page and continuously select **◀▶** the ISO value to which you set camera. Press the set **Set** button. or wait for 8sec. to return to M function screen.

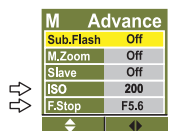

18

ADVANCED CUSTOM SETTING

Advanced custom setting is prepared in this mode.

- Sub Flash Function _____ page 14
- Manual Zoom Setting _____ page 15
- Universal Slave Function _____ page 19

M Advance	
Sub.Flash	Off
M.Zoom	Off
Slave	Off
ISO	200
F.Stop	F5.6

Di866 has a universal wireless remote flash system as a slave unit.

You can enjoy creative flash photography with multiple lightings from the various directions. 2 slave modes are provided in accordance with the flash system of the master flash.



Slave Digital (SD) for digital pre-flash system and Slave Film (SF) for an analogue flash system are available.

SD: In this mode Di866 synchronizes to pre-flash system. The master flash is to be set at TTL/ETTL II mode.

SF: In this mode Di866 synchronizes to the traditional single flash system. The master flash is to be set at manual mode. Studio strobe lighting system synchronizes to this mode. This mode also responds to open flash and to traditional type flash unit in the market.

How to find SD or SF?

Select SD on your slave flash and release your camera's shutter to flash your master flash. The slave flash flashes if the Master flash is SD, and does not flash if the Master flash is SF. If your slave flash is set at SF, it flashes against both of SF and SD flash system.

- To set Di866 to the slave function mode, move cursor  to Slave line at Advanced function page and continuously select  SD or SF in accordance with the system of the master flash you set.
- Press the set  button or wait for 8 sec. to return to M function screen.

M Advance	
Sub.Flash	Off
M.Zoom	Off
Slave	Off
ISO	200
F.Stop	F5.6

M Advance	
Sub.Flash	Off
M.Zoom	Off
Slave	SD
ISO	200
F.Stop	F5.6

19

- Setting of Master and Slave flash:

Setting Master flash:

The master flash to be set is one unit only.

Place the master flash on the camera and switch it on, and set to Manual function mode or set to the camera's built-in flash on. Make sure which mode you chose, digital pre-flash system or analogue flash system.

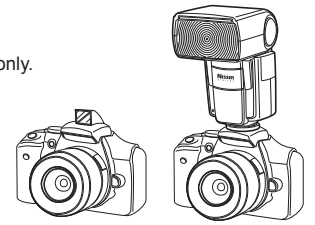

Setting Slave flash Di866:

Multiple numbers of flashes can be set. Switch Di866 on and select the appropriate slave system, either SD or SF.

When flash is set to the slave function, the red LED starts blinking every 2 seconds showing the slave function is in order. Make sure the mode you set, SD or SF which should couple with the master flash system.

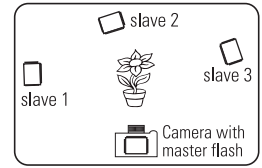

- Set slave flash at any place and direct the flash head as you desire. Slave sensor in the slave flash is facing to the camera or to the master flash.
- Use the included flash stand. Place Di866 on to the flash stand which can be placed either on a flat place or on the tripod by the screw.



NOTE

Metal type accessory shoe is not recommended since it may give electric damage on the electrical contact of the flash hotshoe.

When setting Di866 to the slave function, the zoom setting system is automatically set for the Manual Zoom at 24mm position. The zooming position can be selected manually to any other position available. In this mode, the auto-off timer is recommended to set at 60min. or be cancelled (off). The sensing angle of the slave sensor is 100° approx.







20



Av. Mode Operation

The mode to be set on the camera: [M] or [Av]

The flash light is automatically controlled by the photo sensor built-in the flash unit instead of TTL metering. Select your desired F. Stop on Di866 and set this F. Stop on your camera. The intensity of flash light is automatically controlled for the most proper exposure within the certain area of distance.

- Set the camera mode, to M or Av on your camera.
- Set the mode on Di866. From the 6 icons screen, select  M/Av and set .
- Select  Av and set .
- F. Stop is displayed in the screen in accordance with the ISO setting on the camera.
- Select  your desired F. Stop and set  on the flash unit.
- Press on/off switch to lock the value. (Press it again to release the lock)
- Set the same F. Stop on your camera.
- The display screen shows the F. Stop selected, the camera-subject maximum distance for the proper exposure and the focal length set on the camera.
- The flash light is automatically controlled within the distance area. The shortest distance for the proper exposure is approximately 1.0m(3ft.) from the camera to the subject.
- The distance varies by changing the focal length and F. Stop set on Di866. This Av. mode of Di866 is not coupled with camera's aperture setting. The aperture setting on the flash unit is not controlled by the camera.
- When changing the ISO setting on the camera, the F. Stop of the flash unit is automatically reset for such corresponding ISO value.

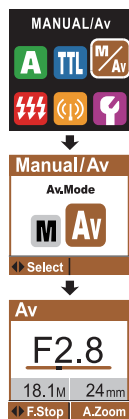

21

- In this case, reset this F. Stop on you camera.
- As for the traditional type cameras, no ISO information or F. Stop information is transferred by the camera. In this case, set ISO value at the Advanced function page of Di866.

ADVANCED CUSTOM SETTING

Advanced custom setting is prepared in this mode.

- Sub Flash Function _____ page 14
- Manual Zoom Setting _____ page 15
- Universal Slave Function _____ page 19

In addition to the Manual power mode, the universal slave function supports Av operation mode.

Setting Slave flash: Select the slave mode SD or SF and set the desired F.stop and ISO speed on the Slave flash. As for setting Master flash, follow to the instruction manual in the Universal slave page at Manual power operation --- Page 20.

22



Multiple Flash Mode (Repeat flash/Stroboscopic flash)

The mode to be set on the camera: [M]

Repeating the flash illumination on the subject freezes the sequence of motion in one frame of picture.

In this mode, the power level, frequency and the number of flashes are to be set on the flash unit in advance.

Power Ratio:

Uncontrolled manual power is provided in 5 steps, from 1/8 to 1/128 power.

Frequency :

1 Hz to 90 Hz frequency can be set.

Flash Times :

1 time to 90 times can be set.

- Set the camera mode to M on your camera.
- Set the shutter speed on your camera in accordance with the guide table in the next page.
- Set the mode on Di866. From the 6 icons screen, select and set
 - Value setting screen is appeared with the default values preset as shown.
 - In this mode, the reflector zooming function is automatically set for option. Either Auto zoom or Manual zoom setting is selectable.
 - Select the function and choose the desired value one by one.
 - Press on/off switch to lock this condition.
 - Or press set or wait for 8 sec. to return the multi flash function screen.

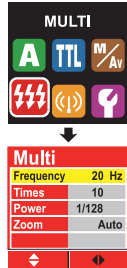

- The use of tripod is recommended for this flash mode.

NOTE

The shutter speed to be set on the camera is calculated in the following formula.

Number of flashes + Frequency = Shutter Speed

Example : To get 20 flashes at 10Hz → 20+10=2

The shutter speed to be set on the camera is 2 sec. or longer.

Shutter for bulb setting is also available.

Guide Table for the number of flashes

Power	Hz	1	2	3	4	5	6-7	8-9	10	11	12-14	15-19	20-50	51-90
1/8		14	14	12	10	8	6	5	4	4	4	4	4	4
1/16		30	30	30	20	20	20	10	8	8	8	8	8	8
1/32		60	60	50	40	30	25	20	12	12	12	12	12	12
1/64		90	90	80	70	50	35	25	20	20	20	20	20	20
1/128		90	90	80	70	50	35	25	20	20	20	20	20	20

Caution

When using an external power pack, you may take continuous frames of multi-exposure pictures. Do not repeat multiple flash more than 10 continuous frames.

Take an interval of 10 to 15 minutes between shots. Flash source may be heated up and may cause serious damage to the flash unit.

Please note that the basic operation is however controlled by the main batteries (battery magazine) in the flash unit and when the main batteries are exhausted, flash control system does not work. Replace the batteries when recycle time becomes longer than 20 seconds by main batteries only. - ref. External Power Pack (page 35)



Wireless Remote Flash Mode

The mode to be set on the camera:

[] (Full Auto), [] (Program), [] (Shutter priority),

[] (Aperture priority), [] (Manual)

Di866 provides two possibilities of off camera wireless remote flash system.

This page explains Wireless Remote flash system. (The other system, universal slave flash system, is prepared at M and Av. mode - Ref. page 19/ 22)

The flash unit placed on the camera, connected by TTL off-camera flash cord is called "Master flash". The master flash to be set is one unit only.

The flash unit placed off the camera is called "Remote Flash" (Canon calls it "Slave"). Multiple number of flashes can be set and controlled in 3 different groups (A, B and C group). 4 channels are prepared for signal transmission between the Master flash and the Remote flash.

Available combination of flash models and cameras

Wireless TTL Flash Pairing Chart

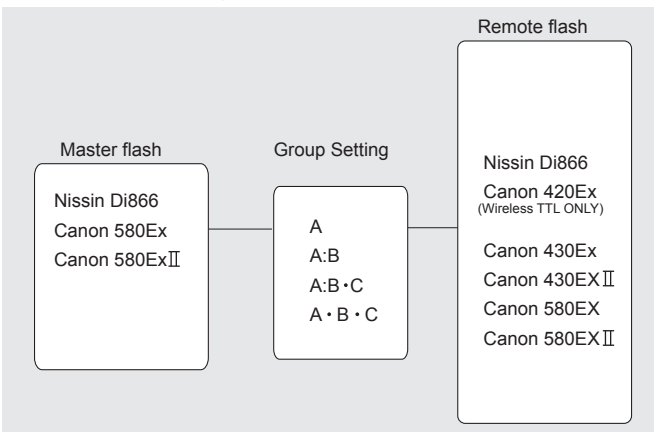

Remote flash

There is no limit of the numbers of remote flash to set in one time.

It is however recommended to set maximum 3pcs in one group, as it may cause interference between flashes depending on the photographic conditions.

Use flash stand to set the Remote flash. The stand provides the flash shoe and can stay either on the flat surface, or be placed on the tripod or light stand by the screw provided at the bottom.

When setting Di866 to Remote flash, it is recommended to cancel the auto-off setting or set it to 60 minutes at the Custom Settings - Ref. page 32.

Refer your flash instruction manual for this function, which may differ according to the flash model.

At Remote flash mode, Di866 is set automatically for manual zoom setting and its reflector position is set for 24mm to cover the wider range of illumination. It is possible to set the desired flash coverage angle manually by select button

Place the Remote flash in consideration to;

1. The slave flash does not shoot its light directly into the camera lens.
2. The wireless flash sensor of the Remote flash is not blocked.
3. The remote flash is usually not placed behind the master flash.
4. In the daylight synchronization, the sensor of remote flash could be saturated by sunlight and its responsibility will extremely be reduced. In this case, the wireless TTL function may not result in success. Making a shade to cover the sensor of remote flash is one of the ideas to help the situation.

Where is the Remote flash sensor?

Remote flash sensor is provided behind the front panel of Di866 at the name of Nissin DIGITAL. The sensor's sensing angle to respond to the incoming light is about 100 degree.

Setting the Master flash

The modes available on the Master flash are TTL and M mode.

The master flash sets the signal transmission channel, flash reflector zooming position, flash mode of the master flash itself and flash mode and value adjustment of the Remote flash at A, B and C respectively.

In the main page

Select Wireless mode.

In the Wireless page

Select Master mode.

In the Master page

Navigate the cursor and adjust the value according to the instruction at the bottom bar.

Cursor Navigation

Value Adjust

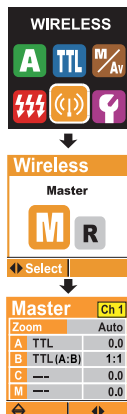

Channel Select

Select Channel: Ch1, Ch2, Ch3 & Ch4

Zoom Select

Select Zoom Mode: Auto, 24mm, 28mm, 35mm, 50mm, 70mm, 85mm, 105mm

Group Setting

Group

M = Master Flash

A = Group A

B = Group B

C = Group C

Group	Flash Mode	Value Adjustment
A	TTL	0.0
B	TTL(A:B)	1:1
C	---	0.0
M	---	0.0

Flash Mode

TTL = TTL Mode

M = Manual Mode

--- = Flash off

Value Adjustment

Ev compensation at TTL mode

(-0.3Ev to +3.0Ev)

Power Ratio at M mode

(1/1, 1/2, 1/4, 1/8, 1/16,

1/32, 1/64, 1/128)

Single Group Slave Flash (Group A Setting)

1. Navigate the cursor to **Group A**
2. Navigate the cursor to **Flash mode** and select mode: TTL or M

Selecting TTL

1. Navigate the cursor to the **Value Adjustment** and set the EV compensation level.
2. Navigate the cursor to M (Master).
3. Select TTL or --- (flash-off) in the **Flash Mode**
4. When TTL mode selected, move the cursor to the **Value Adjustment** and set the EV compensation level.
5. Navigate the cursor to M (Master).
6. Select TTL or --- (FLASH OFF) in the **Flash Mode**.
7. When TTL mode selected, Navigate the cursor to the **Flash Adjustment** and set the power ratio.

Selecting M

1. Navigate the cursor to the **Flash Adjustment** and set the power ratio
2. Navigate the cursor to M (Master).
3. Select M or --- (FLASH OFF) in the **Flash Mode**.
4. When M mode selected, navigate the cursor to the **Flash Adjustment** and set the power ratio.

Note: When setting --- (FLASH OFF) mode, the master flash may flash when shutter released. This flash is however the monitoring flash (pre-flash) before the camera's shutter opens and is not be exposed in the actual picture.

Multiple Group Slave Flash (Group B & C Setting)

Group A **MUST** be set, in order to adding Group B

Adding Group B

When TTL mode selected in Group A

1. Navigate the cursor to GROUP B, and select TTL in the operation mode box.

2. Navigate the cursor to **Flash Adjustment** and select the power level ratio between Group A and Group B.
^The power level ratio can be selected from 13 different combinations, such as A:B = 8:1 – 5.6:1 – 4:1 – 2.8:1 – 2:1 – 1.4:1 – 1:1 – 1:1.4 – 1:2 – 1:2.8 – 1:4 – 1:5.6 and 1:8
3. Navigate the cursor to M (Master).
4. Select TTL or --- (flash-off) in the **Flash Mode**.
5. When TTL mode selected, navigate the cursor to the **Flash Adjustment** and set the EV Compensation.

When M mode selected in Group A

1. Navigate the cursor to GROUP B, and select M in the operation mode box.
2. Navigate the cursor to **Flash Adjustment** and select the power ratio
3. Navigate the cursor to M (Master).
4. Select M or --- (flash-off) in the **Flash Mode**.
5. When M mode selected, navigate the cursor to the **Flash Adjustment** and set the power ratio..

Adding Group C

Group A & B (A:B) **MUST** be set, in order to adding Group C.

^The group C is independently set out from the power ratio combination.

When TTL Mode selected in Group A & B:

1. Navigate the cursor to GROUP C, and select TTL in the **Flash Mode**.
2. Navigate the cursor to **Flash Adjustment** and select the EV compensation.
3. Navigate the cursor to M (Master).
4. Select TTL or --- (flash-off) in the **Flash Mode**.
5. When TTL mode selected, navigate the cursor to the **Flash Adjustment** and set the EV Compensation.

When M Mode selected in Group A & B:

1. Navigate the cursor to GROUP C, and select M in the **Flash Adjustment**.
2. Navigate the cursor to **Flash Adjustment** and select the power ratio.
3. Navigate the cursor to M (Master).

SETTING THE REMOTE FLASH

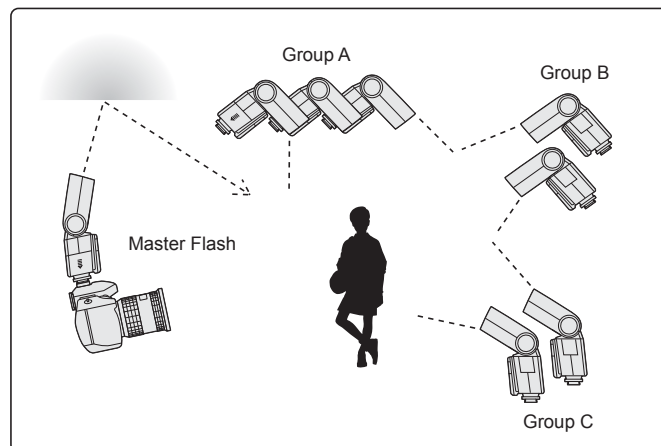

CREATIVE FLASH LIGHTING:

Set Master flash.

Set Slave flash/ flashes.

Make sure the channel and its group setting are correct.

Attach the Master flash to the camera and place the Slave flash/ flashes at any desirable place within the system operation area, which is approximately 7 to 10 meters between the Master and Slave flash/ flashes depending on the setting condition.

Setting the Remote flash

Channel, Group and the flash reflector zooming position are to be set on the Remote flash.

TTL and Manual mode is available on Remote Flash, which can however only be set by the Master flash.

- From the 6 icons screen, select and set . Select and set . AF assist light starts blinking every 2 seconds showing Di866 stands by in Remote Flash mode.
- Select the line channel and set the channel. 4 channels are available from 1 to 4.
- Select the line Group and set the group. 3 groups are available from A to C.
- Select the line Zoom and set zooming position.
- When setting Di866 to the Remote mode, the zoom setting system is automatically set at 24mm position. The zooming position can be selected manually to any other available position.
- Press on/off switch to lock this condition. (Press it again to release the lock).
- Or press set , the screen shows the 6 icons screen and returns back to Remote setting page. The function and the value remain recorded as set.
- When placing more flashes, repeat the same operation procedures instructed above.
- The group can be chosen freely from A, B or C, but the channel of this bundle of wireless flash system is to be set in one common channel. The flash mode and the value can not be set on the Remote flash, but they are set by the Master flash only.

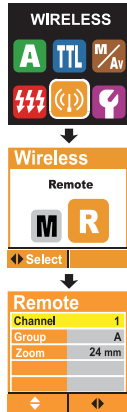

Custom settings

A variety of custom settings enable you to customize your Di866.

- From 6 icons, select Custom setting mode and set .
- Select the item to be customized and set the value to customize.
- 7 custom settings are prepared.

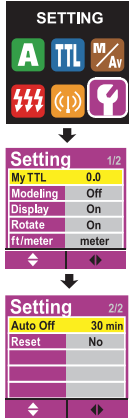

My TTL TTL Exposure level custom setting

TTL exposure level is accurately calibrated for standard balance in accordance with Nissin's standard. If any adjustment is however required, or if you like to set your own preferable level, it can be adjusted for about $\pm 3\text{ev}$. by every 1/3 steps.

Modeling Illuminating the subject to find its lighting efficiency.

A short pulse of flash light released by the test button illuminates the subjects and monitors the lighting efficiency on the subject.

Display Display can be set off if it's not necessary.

To save battery energy, or imply to avoid the display illumination, the display screen can be switched off when not in operation. Set it off, and the display goes off in 8 seconds after the last operation. The display will not be woken up by the camera's shutter release. The display can only be woken up by the operation button of Di866.

Rotate Cancel the rotating action and keep the image fixed. The screen won't rotate.

ft/meter For the user who prefers distance indication by feet. Select ft instead of meter.

Auto Off Auto off timing can be selected from 10min. 15min. 30min. 45min. 60min. or off (cancel).

Reset All those customs setting is reset to the default value and conditions which are provided and set at the factory.

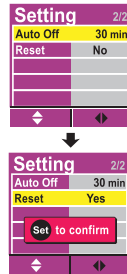

- Those customized value and conditions are effective on all modes(*) and memorized even the flash unit is switched off.
- To reset the customized value or conditions, select Reset, choose "Yes" and set . All the memorized data is cancelled and Di866 is reset to the default value and condition.

Functions by Camera setting

You do not need to set the flash unit for these functions.



F.E Lock

Di866 offers this function at A and TTL mode. Focus the main subject and press button on the camera (or < FEL > button on some cameras. Exposure value on the main subject is memorized in the flash. Aim the viewfinder center over the main subject and release the shutter.



OTHER FEATURES

AF assist light emitter

Under the low light condition or in a dark place, AF assist light will automatically emit the red colored beam and illuminate the subject so that the camera can easily focus the subject in darkness.

Fill-in reflector and Light diffusing panel built-in

For short distance or portrait flash photography, the light should not be too sharp or too strong to the subject. Use fill-in reflector flash or diffuse the light.

- If the subject is close (within 2 meter), turn the flash head 90° upward and pull out the fill-in reflector as shown in the picture.
- Take a picture as usual. A blink of fill-in flash freshens up the subject in natural image.
- This small blink of flash is also useful when taking a picture of baby without scaring him. Pull out the light diffusing panel and place it over the flash window as shown in the picture.
- The diffusing panel softens the flash light and creates a lively color effect upon the subject.
- Since the light diffusing panel expands the lighting area, it covers the range of 18mm of focal length lens.

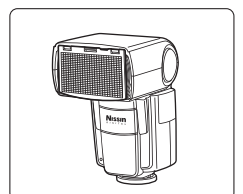
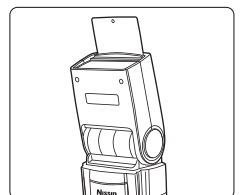
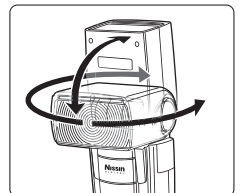

Bounce Lighting

When taking a picture of a baby or small children, do not shoot the flash straight onto them. Bounce the light off the ceiling or wall so that it won't scare them.

When pointing the flash to a subject in front of the wall, it creates an unexpected sharp shadow on the wall which results in poor picture quality. Bounce the light off the ceiling or wall to soften the light over the subject, and the shadow fades out.

Turn the flash head upwards or sideways. The wall or ceiling in this case should be flat surface and white color is preferable. Colored ceiling or wall may reflect its color on the subject.

External Power Pack Socket

When using an external power source, the number of flashes is increased and the recycling time is shortened. The following external power pack is available in option.

Di866 is automatically turned off when repeating flash continuously over

20 to 30 times to protect the flash circuitry. It will be automatically reset after 15minutes of stationary.

Please note that the basic operation is controlled by the main batteries(battery magazine) in the flash unit and when the main batteries are exhausted, the flash control system does not work. Replace the batteries when recycle time becomes longer than 20 seconds by main batteries only.



Battery = NiMH battery	Operation Modes	Recycle time
Nissin Power Pack PRO-300	500 flashes	0.7 sec.
Canon CP-E4	260 flashes	1.5 sec.

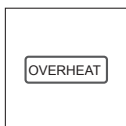

USB Service Port

Tired of your flash no longer working whenever a new camera comes onto the market ? A firmware upgrade service is available for the Di866, which provides a service terminal to upload the latest software. A service charge for the firmware upgrade will be applied, varying with different region. Please check at your local dealer for details about the update service.

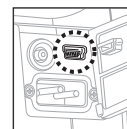

X terminal

Di866 can be used with non-hotshoe cameras. Some cameras provide a flash synchronization contact at x-terminal instead of hotshoe. For this type of cameras, Di866 has a x-terminal socket for flash synchronization. A standard sync-cable in the market is usable.

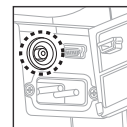

Off-camera shoe cord (Optional)

Di866 can be used together with Nissin SC-01 (Off Camera Shoe Cord). The cord provides a TTL hot shoe at main body. It enable to attach two flash units on the top of camera and the off camera side at the same time.

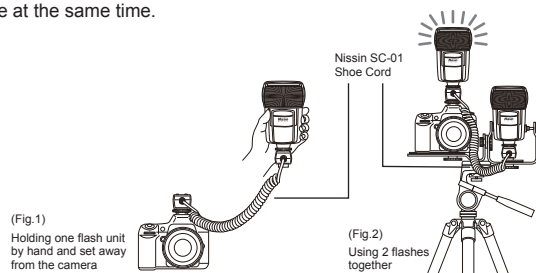

* It is not possible to shoot two flashes at the same time.

SPECIFICATIONS

Usable cameras	Canon E-TTL flash system SLR and hotshoe type compact digital cameras-ref. page 2 for camera models.
Guide No.	60/198 at 105mm focal length (ISO 100 m/ft) 40/132 at 35mm focal length (ISO 100 m/ft)
Wattage	83 Ws. at full power
Illumination coverage	24-105mm (18mm with diffuser panel built-in)
Power source	4 x LR6 batteries (Size AA Ni-MH or lithium batteries usable)
Battery life	150-1500 flashes according to the mode (with alkaline batteries)
Energy Saving	Come to Stand-by mode in 30 sec., and Power off timer can be set
Recycle timer	5.5 sec. with fresh alkaline batteries for full power
Flash Exposure	E-TTL / E-TTL II for Canon digital SLR cameras Automatic exposure metering by external photo sensor Manual exposure (Power ratio available)-Ref G.No. table below
AF assist light	Effective range of approx. 0.7 to 10m / 2.3 to 33 ft.
Color Temperature	5600 K*at full power flash
Flash Duration	1/300 sec. (full power flash) 1/300-1/30,000 sec. (controlled flash)
Wireless flash	FP flash for high speed synchronization Wireless TTL off camera flash system Wireless Master mode Wireless Remote mode Slave flash function at external auto-exposure Slave to digital pre-flash system Slave to traditional single flash system
External Power Pack	Service socket for the external power pack(optional accessory) Nissin Power Power Pack Pro-300 Canon Power Assist Pack CP-E4
USB service port	For firmware update service USB cord is not included
Sync. Contact	Camera's hot shoe-E-TTL for Canon system Traditional sync. System X-terminal socket
Dimensions	74 x 134 x 110mm (29.2 x 53 x 43.5 inch)
Weight	380g

Guide Number and Flash duration table

Guide No. at manual exposure mode (ISO 100 in meters/feet)

Zoom position	Flash Power Level							
	Full	1/2	1/4	1/8	1/16	1/32	1/64	1/128
24mm	31	22	16	11	8	5.5	4	2.5
28mm	36	25	18	12.5	9	6.5	4.5	3
35mm	40	28	20	14	10	7	5	3.5
50mm	46	32	23	16	11.5	8	5.5	4
70mm	52	36	26	18	13	9	6.5	4.5
85mm	54	38	27	19	13.5	9.5	7	5
105mm	60	42	30	21	15	10.5	7.5	5.5
Flash Duration (sec.)	1/600	1/900	1/1500	1/3200	1/5000	1/9000	1/15000	1/22000

TROUBLE SHOOTING

The flash unit does not start charging.

- Batteries are not correctly installed
>>> Install batteries to correct direction.
- Batteries are exhausted
>>> Replace the batteries if the recycle time is beyond 20 sec.

The flash unit does not flash.

- The flash unit is not firmly clipped on the camera
>>> Mount the flash unit firmly on the camera's hot shoe.
- The flash unit is automatically powered off
>>> Turn on the switch again.

The flash picture is overexposed or underexposed.

- There is a reflective object or strong lighting near the subject.
>>> Use Fv lock.
- The unit is set for manual exposure mode at wrong distance
>>> Set to TTL mode or select other power level.

WARANTEE

In case of the following reasons of the defect, it may void the warrantee. Please refer to the respective warrantee condition for details which varies from different countries.

1. The product is not used in accordance with the instruction of the owner's manual.
2. The product is repaired or modified by the one who is not an authorized repair service provider.
3. When the product is used with the inapplicable cameras, lens or adaptors or such accessories produced by the third party.
4. Fault or defect caused by fire, earthquake, flood, public pollution and such natural accidents.
5. in the case that the product is stored in dust, moisture, extremely high temperature or such poor conditions.
6. Scratch, blemish, crush or worn out by a violently use or treatment.
7. Guarantee card without the name of place purchased or the date of purchase stamped, or no guarantee card.